



Spine-B Benching System

Inhaltsverzeichnis	Kapitel	Contents	Chapter
<b>Oberflächen - Farben</b>	01.01 - 01.04	<b>surfaces - colours</b>	01.01 - 01.04
<b>Erläuterungen</b>	02.01 - 02.02	<b>explanations</b>	02.01 - 02.02
<b>Arbeitsstische</b>	03.01	<b>work stations</b>	03.01
<b>Kabelmanagement</b>	04.01 - 04.02	<b>cable management</b>	04.01 - 04.02
<b>Sichtschutzwände</b>	05.01 - 05.03	<b>visual protection screen</b>	05.01 - 05.03
<b>Zubehör</b>	06.01	<b>accessories</b>	06.01
Monitorarme		monitor arms	
CPU-Halter		CPU stand	
Klemm-Leuchte		clamp light	
Kleiderhaken		clothes hook	
<b>Apothekerschränke</b>	07.01 - 07.02	<b>pull-out cupboards</b>	07.01 - 07.02
Schubfach		drawer	
Wertfach		valuable storage	
Verbindungsmodul		connection module	

Edition 02  
 recommended retail price  
 prices in EURO, without VAT  
 valid from July 31st, 2020  
 slight constructional alterations subject to change  
 images almost similar  
 all dimensions are indicated in cm

**Certificates**

the company is certified according to DIN EN ISO 9001:2015

SPINE has received the GS certificate  
 Office Desks - office sitting / standing work table



Bei diesen Artikeln sind unbedingt Farbangaben bei der Bestellung notwendig / colours of the following articles must be indicated in the order:

Artikel	article	Farbcode / colour code
Arbeitsstische	work stations	
- Gestell	- frame	- 029, 094, 095
- Platte	- top	- 011, 024, 026, 041, 042, 049, 051, 081, 083, 085; 111, 122, 131, 132, 161, 181, 191; 078; 701, 702; 084, 086, 087 (Option -SD); 710, 711 (Option -AFP)
Apothekerschranke	pull-out cupboard	
- Korpus innen / außen, Schubfach, Wertfach	- carcass inside / outside, drawer, valuable storage	- 011, 024, 026, 041, 042, 049, 051, 081, 083, 085
- Front	- front	- 011, 024, 026, 041, 042, 049, 051, 081, 083, 085; 111, 122, 131, 132, 161, 181, 191; 078; 701, 702; 084, 086, 087 (Option -FSD)
- Abdeckplatte	- top	- 011, 024, 026, 041, 042, 049, 051, 081, 083, 085; 084, 086, 087 (Option -ASD); 111, 122, 131, 132, 161, 181, 191 (Option -AF); 078 (Option -AMDF); 701, 702 (Option -ABA)
Verbindungsmodul für 2 Apothekerschranke	connection module for 2 pull-out cupboards	- 029, 094, 095
Kabeldurchlass aus Kunststoff, rund	cable outlet made of plastic, round	- 014, 044, 049
Kabeldurchlass aus Kunststoff, eckig	cable outlet made of plastic, square	- 014, 049, 073
Powerdot mini	powerdot mini	- 014, 049
Kabelwanne	cable tray	- 029, 094, 095
Kabelkette mit Standfuß (SNKK1, SBKK2)	cable chain with foot (SNKK1, SBKK2)	
- Kabelkette	- cable chain	- 014, 044, 049
- Standfuß	- foot	- 029, 094, 095
Kabelkette (SBKK3, SBKK4)	cable chain (SBKK3, SBKK4)	- 014, 044, 049
CPU-Halter	CPU stand	- 029, 094, 095
Klemm-Leuchte	clamp light	- 094, 095
Kleiderhaken	clothes hook	- 029, 094, 095
Sichtschutzwände	visual protection screen	
Stoffbezug Sichtschutzwand 1, Stoffgruppe 1	fabric visual protection screen 1, group 1	- Camira Yoredale UDA01, UDA02, UDA03, UDA04, UDA05, UDA06, UDA07, UDA08, UDA09, UDA10, UDA11, UDA12, UDA13, UDA14, UDA15, UDA16, UDA17, UDA18, UDA19, UDA20, UDA21, UDA22, UDA23, UDA24, UDA25
Stoffbezug Sichtschutzwand 2, Stoffgruppe 1	fabric visual protection screen 2, group 1	- Camira Synergy LDS08, LDS16, LDS17, LDS19, LDS29, LDS32, LDS44, LDS49, LDS54, LDS57, LDS59, LDS74, LDS84
Halterungen für Sichtschutzwände	mounting brackets for visual protection screens	- 029, 094, 095

Farbkürzel / colour codes

011	lichtgrau	light grey	086	Rodach Eiche Dekor	Rodach oak decor
014	schwarz	black	087	Coburg Ulme Dekor	Coburg elm decor
024	Buche Dekor	beech decor	094	schwarz glatt	black smooth
026	Ahorn Dekor	maple decor	095	kristallweiß glatt	crystal white smooth
029	silber metallic	silver metallic	111	Echtholz Buche	beech veneer
041	weißaluminium	aluminium white	122	Echtholz Esche schwarz offenporig	ash tree black open-pored veneer
042	Weißbuche Dekor	light beech decor	131	Echtholz Ahorn europäisch	European maple veneer
044	alugrau	aluminium grey	132	Echtholz Ahorn kanadisch	Canadian maple veneer
049	kristallweiß	crystal white	161	Echtholz Nussbaum	walnut veneer
051	Balearen Eiche Dekor	Balearic oak decor	181	Echtholz Eiche	oak veneer
073	silbergrau	silver grey	191	Echtholz Kirschbaum	cherry veneer
078	Beton Optik	concrete optic	701	Bambus natur	bamboo nature
081	Kirschbaum Dekor	cherry tree decor	702	Bambus Mokka	bamboo mocha
083	Beton Dekor	concrete decor	710	Weiß matt	matt white
084	Meeder Eiche Dekor	Meeder oak decor	711	Schwarz matt	matt black
085	Royal Weiß	royal white			

**Wichtiger Hinweis:**

Holz ist ein gewachsener Werkstoff. Kein Stamm gleicht dem anderen. Die einzelnen Stämme unterscheiden sich in Maserung und Farbe. Aber auch innerhalb eines Stammes treten Struktur- und Tonunterschiede auf. Unter Lichteinwirkung und durch extrem feuchtes oder trockenes Klima kann sich die Holzfarbe ändern. Unterschiede, Unregelmäßigkeiten und Veränderungen, die aufgrund der natürlichen Beschaffenheit des Holzes auftreten, sind kein Grund zur Beanstandung.

Die Furniere werden sorgfältig und kommissionsweise ausgewählt. Soweit möglich verwenden wir für einen Auftrag Furnier aus einem Stamm. Dadurch werden die Unterschiede in Struktur und Färbung so gering wie möglich gehalten.

Bei Nachlieferungen sind Unterschiede in Struktur und Färbung kein Grund zur Beanstandung.

**Important note:**













Wood is a grown material. No trunk of a tree is alike the other. The single trunks are different in grain and colour. Also within a trunk there are differences in structure and tone. When exposed to light radiation and in an extremely humid or extremely dry climate the wood colour can change. Differences and changes caused by the natural quality of the wood are no reason for complaint.

The veneer will be chosen carefully and separately for each commission. As far as possible we use veneer of the same trunk for one order.

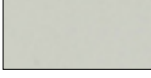

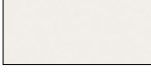

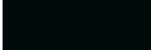

This helps to keep differences in structure and colour as low as possible.

Differences in structure and colour are no reason for complaint in subsequent deliveries.

**Platte (Melamin)**  
Top (melamine surface)

	024 Buche Dekor beech decor
	026 Ahorn Dekor maple decor
	042 Weißbuche Dekor light beech decor
	051 Balearen Eiche Dekor Balearic oak decor
	081 Kirschbaum Dekor cherry tree decor
	083 Beton Dekor concrete decor
	011 lichtgrau light grey
	041 weißaluminium aluminium white
	049 kristallweiß crystal white
	085 Royal Weiß royal white
	084 (Option -SD) Meeder Eiche Dekor Meeder oak decor
	086 (Option -SD) Rodach Eiche Dekor Rodach oak decor
	087 (Option -SD) Coburg Ulme Dekor Coburg elm decor
	710 (Option -AFP) Weiß matt matt white
	711 (Option -AFP) Schwarz matt matt black

**Platte (Furnier Echtholz)**  
Top (veneer surface real wood)

	111 Echtholz Buche beech veneer
	122 Echtholz Esche schwarz offenporig ash tree open-pored veneer
	131 Echtholz Ahorn europäisch European maple veneer
	132 Echtholz Ahorn kanadisch Canadian maple veneer
	161 Echtholz Nussbaum walnut veneer
	181 Echtholz Eiche oak veneer
	191 Echtholz Kirschbaum cherry veneer

**Platte (MDF lackiert)**  
Top (MDF lacquered)

	078 Beton Optik concrete optic
---	--------------------------------------



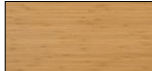





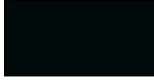

**Platte (Bambus)**  
Top (bamboo)

	701 Bambus natur Bamboo nature
	702 Bambus Mokka Bamboo mocha

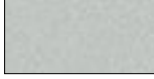
**Kabeldurchlass**  
Cable outlet

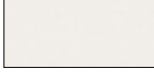

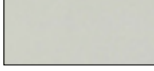



	014 schwarz black		014 schwarz black
	044 alugrau aluminium grey		073 silbergrau silver grey
	049 kristallweiß crystal white		049 kristallweiß crystal white

**Apothekerschrank: Korpus innen / außen, Front, Abdeckplatte, Schubfach, Wertfach (Melamin)**  
Pull-out cupboard: carcass inside / outside, front, top, drawer, valuable storage (melamine surface)



	024 Buche Dekor beech decor		081 Kirschbaum Dekor cherry tree decor		014 schwarz black
	026 Ahorn Dekor maple decor		083 Beton Dekor concrete decor		041 weißaluminium aluminium white
	042 Weißbuche Dekor light beech decor		085 Royal Weiß royal white		049 kristallweiß crystal white
	051 Balearen Eiche Dekor Balearic oak decor		011 lichtgrau light grey		072 graphit graphite

**Apothekerschrank: Front, Abdeckplatte**  
Pull-out cupboard: front, top

Furnier Echtholz / veneer surface real wood

	111 Echtholz Buche beech veneer		161 Echtholz Nussbaum walnut veneer
	122 Echtholz Esche schwarz offenporig ash tree black open-pored veneer		181 Echtholz Eiche oak veneer
	131 Echtholz Ahorn europäisch European maple veneer		191 Echtholz Kirschbaum cherry veneer
	132 Echtholz Ahorn kanadisch Canadian maple veneer		

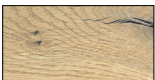

Melamin / melamine surface

	084 (Option -ASD, -FSD) Meeder Eiche Dekor Meeder oak decor
	086 (Option -ASD, -FSD) Rodach Eiche Dekor Rodach oak decor
	087 (Option -ASD, -FSD) Coburg Ulme Dekor Coburg elm decor

MDF lackiert / MDF lacquered

	078 Beton Optik concrete optic
---	--------------------------------------

Bambus / bamboo

	701 Bambus natur Bamboo nature
	702 Bambus Mokka Bamboo mocha

nur für Abdeckplatte / only for top

	710 (Option -AFP) Weiß matt matt white
	711 (Option -AFP) Schwarz matt matt black

**Gestell, Kabelwanne, CPU-Halter, Monitorarme, Kleiderhaken, Halterungen Sichtschutzwände, Verbindungsmodul**

Frame, cable tray, cpu stand, monitor arms, clothes hook, mounting brackets for visual protection screen, connection module



029  
silber metallic  
silver metallic



095  
kristallweiß glatt  
crystal white smooth

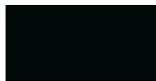

094  
schwarz glatt  
black smooth

**Kabelketten / Cable chains**

**Standfuß / foot**



029  
silber metallic  
silver metallic

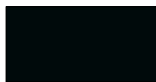

094  
schwarz glatt  
black smooth

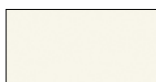

095  
kristallweiß glatt  
crystal white smooth

**Kabelkette / cable chain**

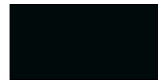

014  
schwarz  
black



044  
alugrau  
aluminium grey



049  
kristallweiß  
crystal white

**Klemmleuchte / clamp light**

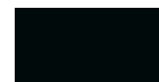

094  
schwarz glatt  
black smooth

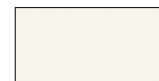

095  
kristallweiß glatt  
crystal white smooth

**Sichtschutzwand 1, Stoffgruppe 1 (Camira Yoredale) / Visual protection screen 1 , fabric group 1**

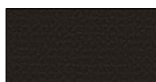

UDA01 Buckden



UDA02 Kidstone



UDA03 Askrigg



UDA04 Hardraw



UDA05 Simonstone



UDA06 Thoraby



UDA07 Carperby



UDA08 Gayle



UDA09 Thornton



UDA10 Cray



UDA11 Fossdale



UDA12 Woodale



UDA13 Walden



UDA14 Sedbusk

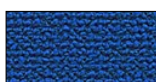

UDA15 Litton



UDA16 Nidd

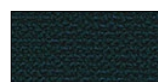

UDA17 Ribble



UDA18 Wharfe



UDA19 Ripley

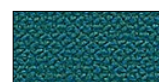

UDA20 Darley

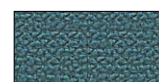

UDA21 Dacre

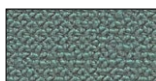

UDA22 Burnsall



UDA23 Cracoe



UDA24 Woden

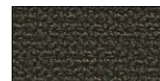

UDA25 Leyburn

**Sichtschutzwand 2, Stoffgruppe 1 (Camira Synergy) / Visual protection screen 2, fabric group 1**



LDS08 Serendipity



LDS16 Partner

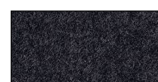

LDS17 Mix



LDS19 Chain

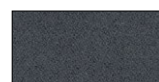

LDS29 Hook



LDS32 Affix

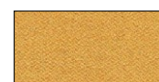

LDS44 Relate

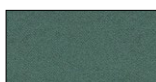

LDS49 Append

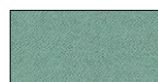

LDS54 Regard



LDS57 Engage



LDS59 Group



LDS74 Affinity

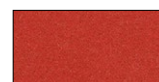

LDS84 Mutual

Aufbauprinzip

basic structure

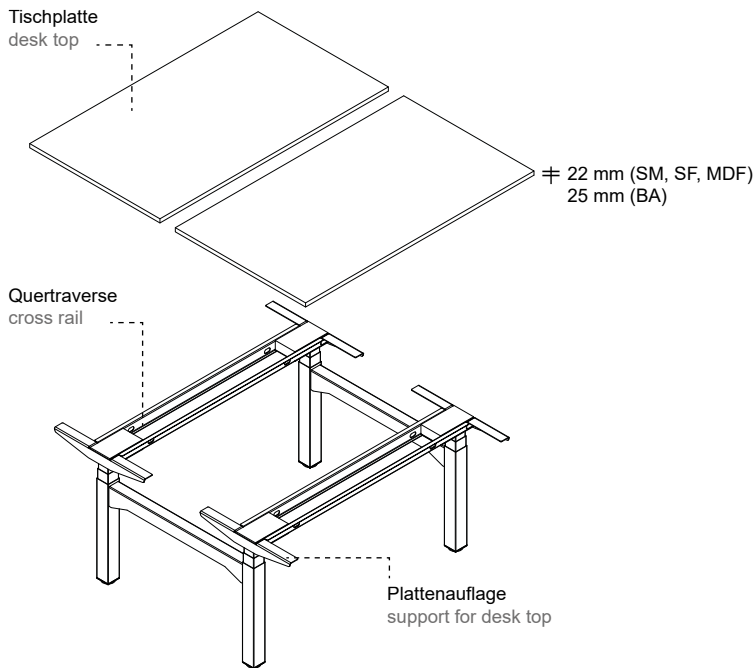

Die Arbeitstische werden zerlegt geliefert.  
The work stations will be delivered demounted.

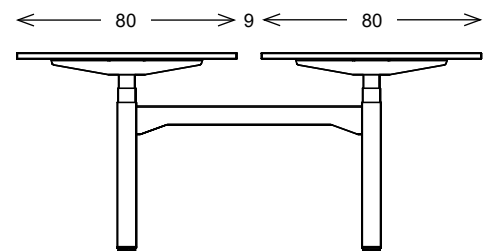

Höhenverstellung

height adjustment

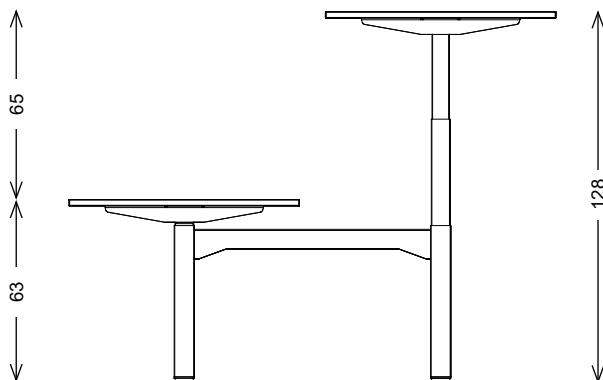

**Doppel-Teleskop**

- Höhe verstellbar von 63 - 128 cm
- Verstellart M3, M4
- Belastung 0 - 75 kg

**Motorverstellung M3**

- im Gestell integrierter, leise laufender Elektromotor
- Verstellgeschwindigkeit: max. 36 mm/s
- geringes Geräuschniveau 39-46 dB(A)
- Softstart, Softstop
- SafetyStop
- Tastschalter auf / ab

**Motorverstellung M4**

- wie M3, aber Komfortsteuerung mit Höhenanzeige und 4 Memory-Positionen

**double telescope**

- working height adjustable from 63 - 128 cm

**adjustment M3**

- weight bearing 0 - 75 kg
- height adjustment by motor M3
- quiet electro motor integrated in the frame
- speed of adjustability: max. 36 mm/s
- low noise level 39-46 dB (A)
- softstart, softstop
- SafetyStop
- push-button up / down

**height adjustment by motor M4**

- similar with M3 but comfort control including LED display and 4 memory positions

Kabelmanagement

cablE management

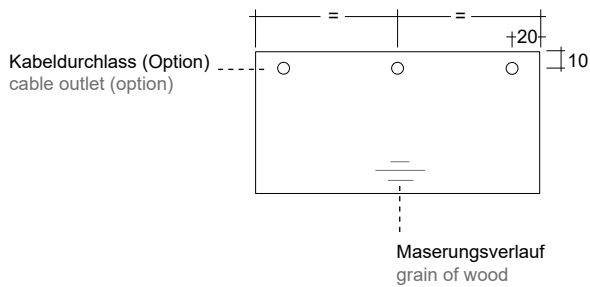
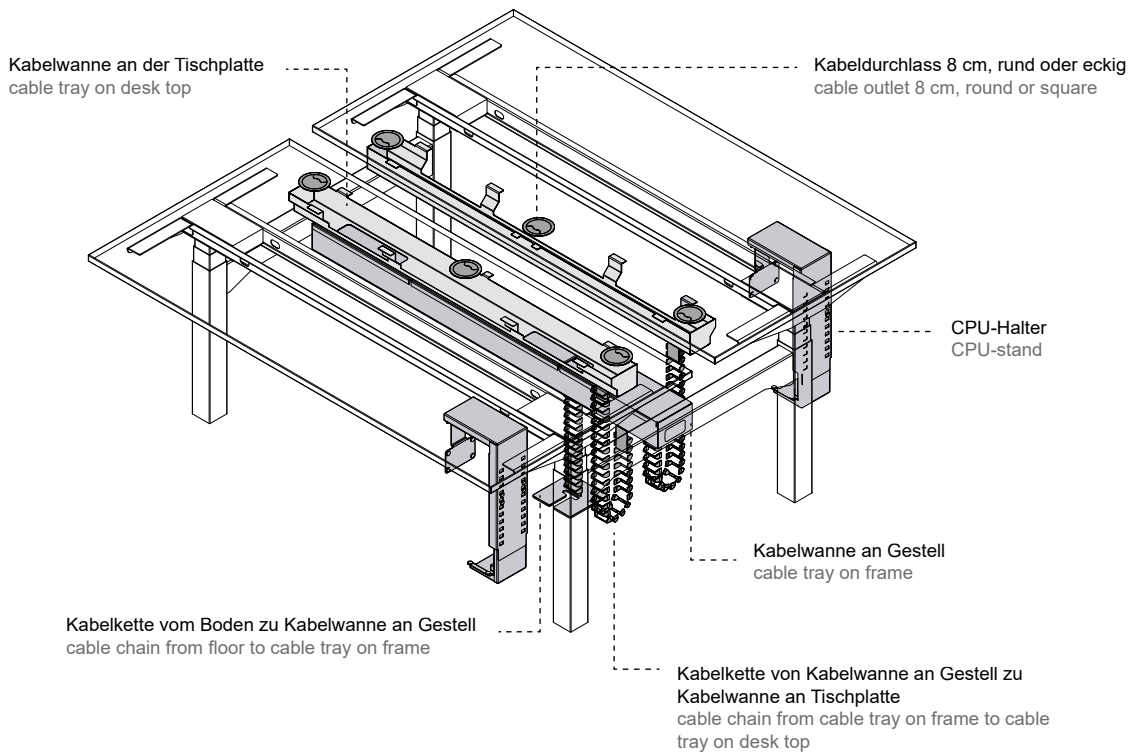



**Aufbauprinzip**

**basic structure**

**Variante 1: hoch schallabsorbierend**

- Höchst schallabsorbierend nach DIN EN ISO 354
- Füllstoff B1 schwerentflammbar nach DIN 4102-1
- Füllstoff OEKO-TEX Standard 100

Textilinformationen

- 95% Wolle, 3% Polyester, 2% Polyamid
- ≥50.000 Scheuertouren
- EN 1021 - 1, EN 1021 - 2, BS 7176 Low Hazard

**Variante 2**

Textilinformationen

- 95% Schurwolle, 5% Polyamid
- 100.000 Scheuertouren
- EN 1021 - 1, EN 1021 - 2, BS 7176 Low Hazard

**Variant 1: highly sound absorbing**

- highly sound absorbing, DIN EN ISO 354
- filling material fire class B1, DIN 4102-1
- filling material OEKO-TEX Standard 100

textile information

- 95% Wool, 3% Polyester, 2% Polyamide
- Abrasion Resistance ≥50,000
- EN 1021 - 1, EN 1021 - 2, BS 7176 Low Hazard

**Variant 2**

textile information

- 95% New Wool, 5% Polyamide
- Abrasion Resistance 100.000
- EN 1021 - 1, EN 1021 - 2, BS 7176 Low Hazard

**► Tisch in Einzelstellung**

**desk single positioned**

- seitliche Sichtschutzwände nur in Verbindung mit Mittelwand möglich
- seitliche Sichtschutzwände hoch, niedrig können an beiden Seiten des Tisches angebunden werden
- für seitliche Wände müssen zusätzlich Halterungen bestellt werden

- lateral visual protection screens only in combination with central screen possible
- lateral visual protection screens high, low can be added on both sides of the desk
- additional mounting brackets must be ordered for lateral screens

Sichtschutzwand Mitte niedrig  
inkl. Halterungen zur Befestigung am Gestell  
visual protection screen center low  
incl. mounting brackets on frame

Sichtschutzwand seitlich hoch (2-teilig)  
Halterungen müssen extra bestellt werden!  
lateral visual protection screen high (split)  
mounting brackets must be ordered separately!

Sichtschutzwand seitlich niedrig  
Halterungen müssen extra bestellt werden!  
lateral visual protection screens, low  
mounting brackets must be ordered separately!

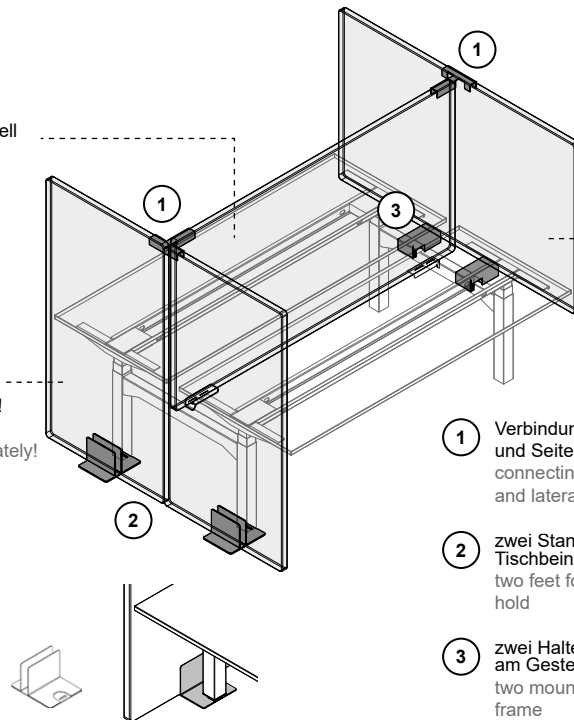

- ① Verbindungselement T-Form zur Fixierung von Mittelwand und Seitenwand  
connecting element T shaped for fixing of central screen and lateral screen
- ② zwei Standfüße für Seitenwand hoch, zum Aufstellen der Tischbeine für festen Halt  
two feet for lateral screen high, to put on the desk legs for firm hold
- ③ zwei Halterungen zur Befestigung der Seitenwand niedrig am Gestell  
two mounting brackets for fixing of lateral screen low on the frame

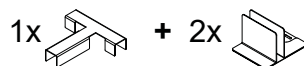

- ① + ② Halterungen Art. SBSWHHE für Sichtschutzwand seitlich hoch  
mounting brackets art. SBSWHHE for lateral visual protection screen high



- ① + ③ Halterungen Art. SBSWNHE für Sichtschutzwand seitlich niedrig  
mounting brackets art. SBSWNHE for lateral visual protection screen low

Aufbauprinzip

basic structure

► Tische in Reihenaufstellung / Weiterverkettung

desk in side-by-side positioning / further connecting

- Seitliche Sichtschutzwand hoch bei Weiterverkettung nicht möglich, nur am Ende der Reihe
- Seitliche Sichtschutzwände nur in Verbindung mit Mittelwand möglich
- Für seitliche Wände müssen zusätzlich Halterungen bestellt werden

- lateral visual protection screen high for further connecting not possible, only at the end of the row
- lateral visual protection screen only in combination with central screen possible
- additional mounting brackets must be ordered for lateral screens

④ Verbindungselement Kreuz-Form zur Fixierung der beiden Mittelwände und der Seitenwand  
connecting element cross shaped for fixing of both central screens and lateral screen

⑤ zwei Halterungen zur Befestigung der Seitenwand niedrig an den beiden Gestellen  
two mounting brackets for fixing of lateral screen low on the frame

④ + ⑤ Halterungen Art. SBSWNHR für Sichtschutzwand seitlich niedrig bei Reihenaufstellung  
mounting brackets art. SBSWNHR for lateral visual protection screen low for side-by-side positioning

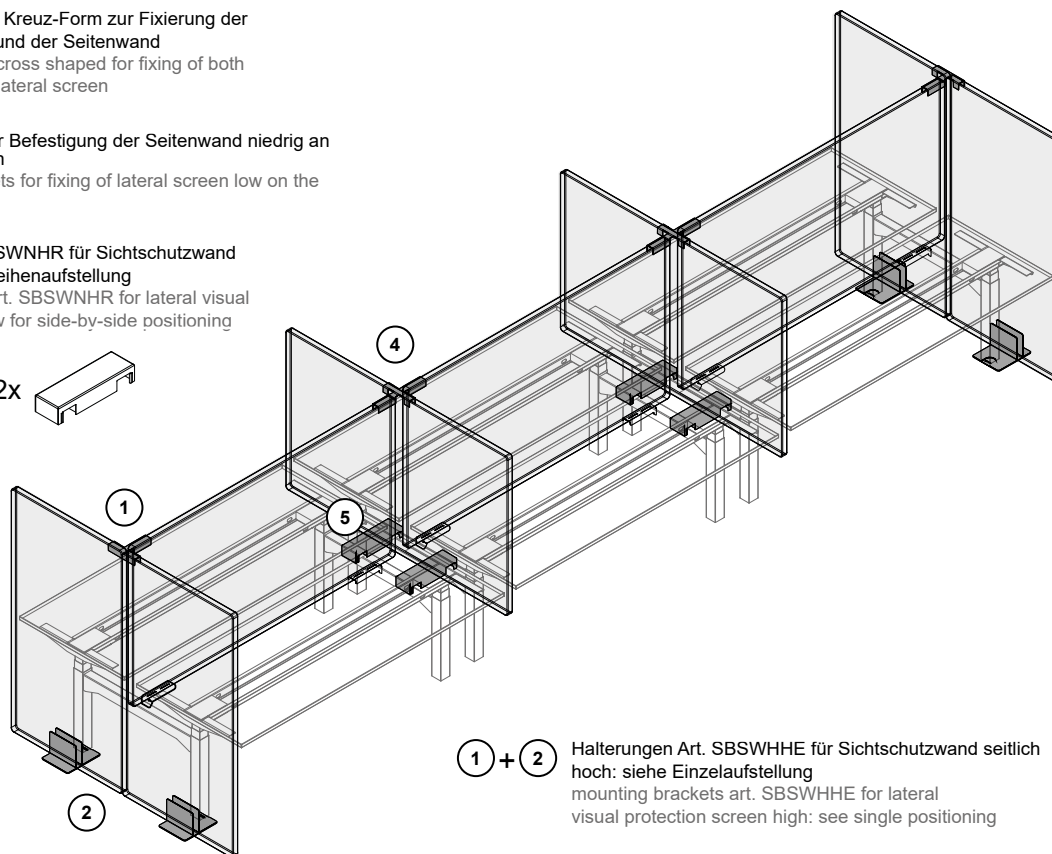
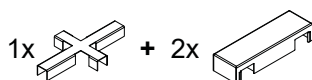

① + ② Halterungen Art. SBSWHHE für Sichtschutzwand seitlich hoch: siehe Einzelaufstellung  
mounting brackets art. SBSWHHE for lateral visual protection screen high: see single positioning

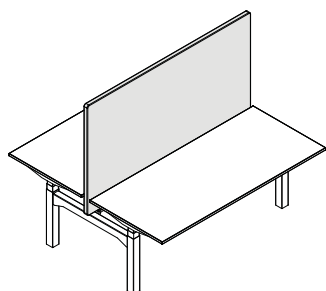

- inkl. Halterungen zur Befestigung am Tischgestell
- incl. mounting brackets for fixing on desk frame

Contact Corona Group for pricing  
and additional product information.



---

where custom is standard

p. 205.941.1942

Birmingham, AL

[info@coronagroupinc.com](mailto:info@coronagroupinc.com)

[coronagroupinc.com](http://coronagroupinc.com)